

# Arki Sofa

**PEDRALI**<sup>®</sup>

AS0010 - AS0111- AS0012 - AS0020 - AS0121 - AS0022 - AS0030 -  
AS0031 - AS0040

100%  
MADE IN  
ITALY

DESIGN  
Pedrali R&D



**EN: Sofa with polyurethane foam cushions with water-repellent fabric-covered cover. Extruded aluminium frame with elastic straps and stainless steel legs. S/steel tube and teak Ø40 mm backrest and armrests**

IT: Divano con cuscini in schiumato poliuretano con fodera idrorepellente rivestita in tessuto. Struttura in estruso di alluminio con cinghie elastiche e gambe in acciaio inox. Schienale e braccioli in tubo in acciaio inox e teak Ø40 mm

DE: Sofa mit Polyurethanschäum-Kissen mit wasserabweisendem Stoffbezug. Gestell aus stranggepresstem Aluminium mit elastischen Bändern und Beinen aus rostfreiem Stahl. Rückenlehne und Armlehnen aus Stahlrohr und Teakholz Ø40 mm

FR: Canapé avec coussins en mousse de polyuréthane avec revêtement en tissu hydrofuge. Structure en aluminium extrudé avec sangles élastiques et pieds en acier inoxydable. Dossier et accoudoirs en tube d'acier inoxydable et teak Ø40 mm

ES: Sofá con cojines de espuma de poliuretano con funda de tela repelente al agua. Marco de aluminio extruido con correas elásticas y patas de acero inoxidable. Respaldo y reposabrazos de tubo de acero inoxidable y teca de Ø40 mm

mm - in

## • AS0010

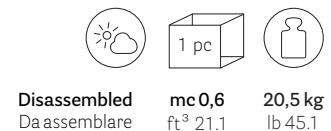
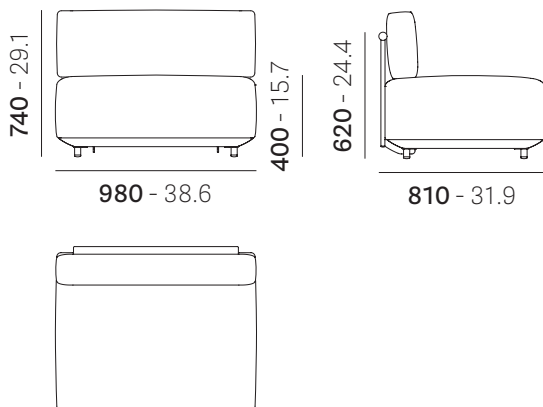

**Disassembled**  
Da assemblare

**mc 0,6**  
ft<sup>3</sup> 21.1

**20,5 kg**  
lb 45.1

## • AS0111

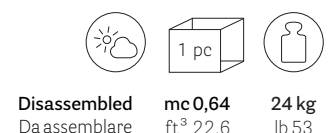
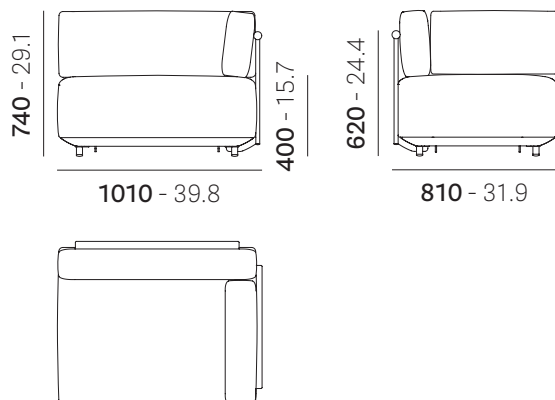

**Disassembled**  
Da assemblare

**mc 0,64**  
ft<sup>3</sup> 22.6

**24 kg**  
lb 53

**EN: Possibility of mounting the armrest on either the right or left side**

IT: Possibilità montaggio bracciolo sia a destra che a sinistra

Reproduction of this document is strictly prohibited without prior written authorisation from Pedrali SpA. Sizes, weights and finishes may change without previous notice.  
È vietata la riproduzione del seguente documento senza previa autorizzazione scritta da parte di Pedrali SpA. Dimensioni, pesi e finiture possono variare senza alcun preavviso.

ST\_ARKI-SOFA\_AS\_2023.0

# Arki Sofa

**PEDRALI**®

AS0010 - AS0111- AS0012 - AS0020 - AS0121 - AS0022 - AS0030 -  
AS0031 - AS0040

DESIGN  
Pedrali R&D

## • AS0012

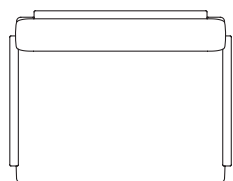
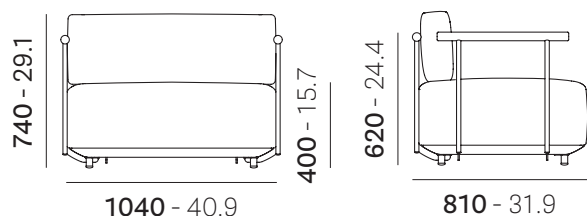

**Disassembled**  
Da assemblare

**mc 0,6**  
ft<sup>3</sup> 21.1

**25 kg**  
lb 55.1

## • AS0020

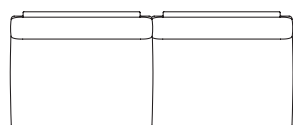
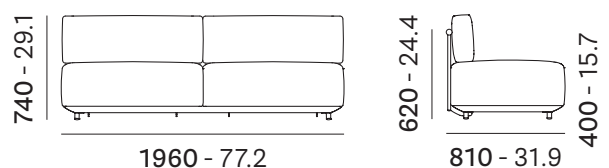

**Disassembled**  
Da assemblare

**mc 1,17**  
ft<sup>3</sup> 41.3

**44 kg**  
lb 97

## • AS0121

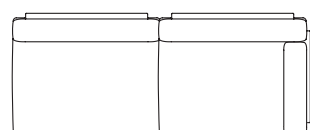
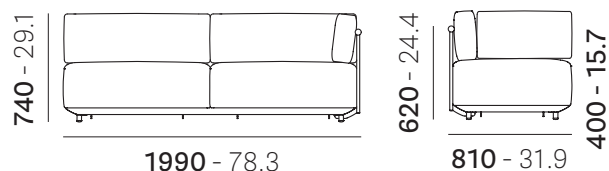

**Disassembled**  
Da assemblare

**mc 1,21**  
ft<sup>3</sup> 42.7

**47,5kg**  
lb 104.7

EN: Possibility of mounting the armrest on either the right or left side  
IT: Possibilità montaggio bracciolo sia a destra che a sinistra

Reproduction of this document is strictly prohibited without prior written authorisation from Pedrali SpA. Sizes, weights and finishes may change without previous notice.  
È vietata la riproduzione del seguente documento senza previa autorizzazione scritta da parte di Pedrali SpA. Dimensioni, pesi e finiture possono variare senza alcun preavviso.

ST\_ARKI-SOFA\_AS\_2023 0

# Arki Sofa

**PEDRALI**®

AS0010 - AS0111- AS0012 - AS0020 - AS0121 - AS0022 - AS0030 -  
AS0031 - AS0040

DESIGN  
Pedrali R&D

## • AS0022

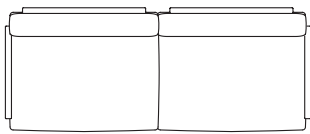
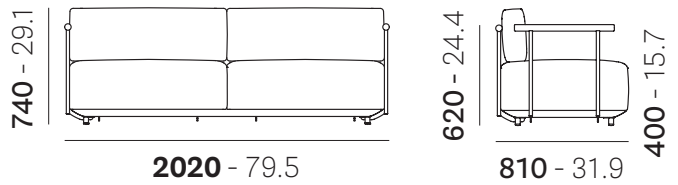

Disassembled  
Da assemblare

mc 1,17  
ft<sup>3</sup> 41.3

48,5 kg  
lb 107

## • AS0030

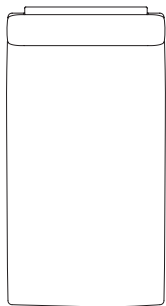
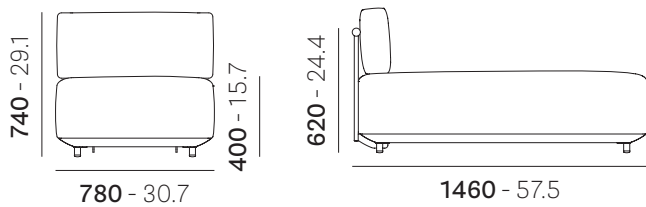

Disassembled  
Da assemblare

mc 0,85  
ft<sup>3</sup> 30

30,5 kg  
lb 67.2

## • AS0031

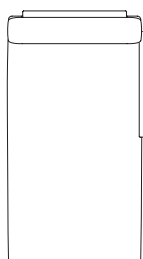
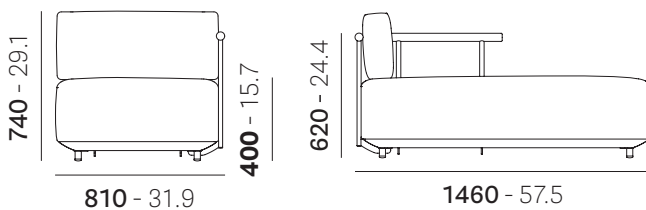

Disassembled  
Da assemblare

mc 0,85  
ft<sup>3</sup> 30

33 kg  
lb 72.7

EN: Possibility of mounting the armrest on either the right or left side  
IT: Possibilità montaggio bracciolo sia a destra che a sinistra

Reproduction of this document is strictly prohibited without prior written authorisation from Pedrali SpA. Sizes, weights and finishes may change without previous notice.  
È vietata la riproduzione del seguente documento senza previa autorizzazione scritta da parte di Pedrali SpA. Dimensioni, pesi e finiture possono variare senza alcun preavviso.

ST\_ARKI-SOFA\_AS\_2023.0

AS0010 - AS0111 - AS0012 - AS0020 - AS0121 - AS0022 - AS0030 - AS0031 - AS0040

DESIGN  
Pedrali R&D

## • AS0040

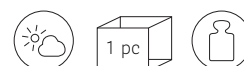
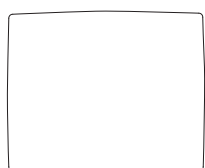
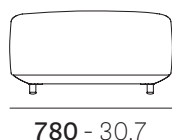
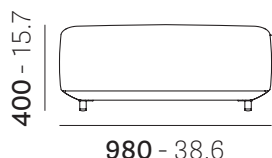

**Disassembled**    **mc 0,6**    **16,5 kg**  
Da assemblare    ft<sup>3</sup> 21.1    lb 36.3

## MATERIALS

Materiali  
Materialien  
Matériaux  
Materiales

### • SEAT CUSHION - CUSCINO SEDUTA - SITZKISSEN - COUSSIN DE ASSISE - COJÍN DEL ASIENTO

**EN: Seat cushions padded with expanded flexible polyurethane (density 40 kg/m<sup>3</sup>), fire-retardant (certified 1IM, Crib 5) with a water-repellent lining and covered with fabric**

IT: Cuscini sedile, imbottiti con poliuretano espanso (densità 40 kg/m<sup>3</sup>), ignifugo (classe 1 IM, Crib 5) con fodera idrorepellente per esterno e rivestito in tessuto

DE: Sitzkissen gepolstert mit flexiblem Polyurethan (Dichte 40 kg/m<sup>3</sup>), feuerfest (Klasse 1 IM, Crib 5) mit wasserdichtem Futter für den Außenbereich und mit Stoff bezogen

FR: Coussins de assise rembourrée en polyuréthane expansé flexible (densité 40 kg/m<sup>3</sup>), ignifuge (classe 1 IM, Crib 5) avec doublure déperlante pour l'extérieur et recouverte d'un tissu

ES: Cojines asiento tapizado de espuma de poliuretano flexible (densidad 40 kg/m<sup>3</sup>), ignífugo (clase 1IM, Crib 5) con funda repelente al agua para exterior y tapizados con tejido

### • BACKREST CUSHION - CUSCINO SCHIENALE - RÜCKENLEHNENPOLSTER - COUSSIN DU DOSSIER - COJÍN DEL RESPALDO

**EN: Back cushions padded with expanded flexible polyurethane (density 30 kg/m<sup>3</sup>) with a water-repellent lining and covered with fabric**

IT: Cuscini schienale, imbottiti con poliuretano espanso (densità 30 kg/m<sup>3</sup>), ignifugo (classe 1 IM, Crib 5) con fodera idrorepellente per esterno e rivestito in tessuto

DE: Rückenkissen mit flexiblem Polyurethan (Dichte 30 kg/m<sup>3</sup>), feuerfest (Klasse 1 IM, Crib 5) mit wasserdichtem Futter für den Außenbereich und mit Stoff bezogen

FR: Coussins de dossier rembourrée en polyuréthane expansé flexible (densité 30 kg/m<sup>3</sup>), ignifuge (classe 1 IM, Crib 5) avec un doublure déperlante pour l'extérieur et recouverte d'un tissu

ES: Cojines respaldo tapizado de espuma de poliuretano flexible (densidad 30 kg/m<sup>3</sup>), ignífugo (clase 1IM, Crib 5) con funda repelente al agua para exterior y tapizados con tejido

### FABRIC - TESSUTO - STOFF - TISSU - TEJIDO

Cat. D22÷D26 - D80÷D89 - D100÷D105 - D110÷D114 - D130

**EN: For more information see finishing legend on the website**

IT: Per maggiori informazioni vedere legenda finiture sul sito web

### • BACKREST SUPPORT - SUPPORTO SCHIENALE - RÜCKENSTÜTZE - SUPPORT DOSSIER - SOPORTE RESPALDO

**EN: Stainless steel frame, Ø20 mm tube and Ø40 mm Teak wood bar**

IT: Struttura in acciaio inox, tubo Ø20 mm e parte superiore in legno Teak Ø40 mm

DE: Gestell aus rostfreiem Stahl, Ø20 mm Rohr und Ø40 mm Teakholzstange

FR: Cadre en acier inoxydable, tube de Ø20 mm et barre de teck de Ø40 mm

ES: Marco de acero inoxidable, tubo de Ø20 mm y barra de madera de teca de Ø40 mm

### • FRAME - TELAIO - GESTELL - STRUCTURE - ESTRUCTURA

**EN: Aluminium extrusion with elastic belts**

IT: Alluminio estruso con cinghie elastiche

DE: Aluminium extrudiert mit elastischen Gurten

FR: Aluminium extrusion avec sangles élastiques

ES: Aluminio extrusión con cinchas elásticas

AS0010 - AS0111- AS0012 - AS0020 - AS0121 - AS0022 - AS0030 -  
AS0031 - AS0040

DESIGN  
Pedrali R&D

## • LEGS - GAMBE - FÜßE - PIEDS - PATAS

**EN: Stainless steel, tube Ø30 mm**

IT: Acciaio inox, tubo Ø30 mm

DE: Rostfreier Stahl, Rohr Ø30 mm

FR: Acier inoxydable, tube Ø30 mm

ES: Acero inoxidable, tubo Ø30 mm

## LEGS FINISH - FINITURA GAMBE - FÜßE AUSFÜHRUNG - PIEDS FINITION - ACABADO DE LAS PATAS

**EN: Powder coating**

IT: Verniciato con polvere

DE: Pulverbeschichtet

FR: Époxy à poudre

ES: Barnizado con polvo



BI200E BE100E TEE MGE

**EN: For more information see finishing legend on the website**

IT: Per maggiori informazioni vedere legenda finiture sul sito web

## • FEET - PIEDINI - GLEITER - PATINS - TACOS

**EN: Technopolymer feet, black**

IT: Piedino in tecnopolimero, nero

DE: Gleiter Technopolymer, Schwarz

FR: Patis en technopolymère, noir

ES: Tacos en tecnopolimero, negro

## ACCESSORIES

Accessori  
Zubehör  
Accessoires  
Accesorios

### code COVER001 - COVER004 - COVER005

**EN: Protective cover**

IT: Copertura protettiva

DE: Schutzhülle

FR: Couverture protectrice

ES: Cubierta protectora

### code AS\_LINK

**EN: Connecting hook**

IT: Gancio di collegamento

DE: Verbindungshaken

FR: Crochet de connexion

ES: Gancho de conexión

AS0010 - AS0111- AS0012 - AS0020 - AS0121 - AS0022 - AS0030 - AS0031 - AS0040

DESIGN  
Pedrali R&D

## REGULATIONS AND CERTIFICATES

Normative e Certificazioni  
Bestimmungen und Zertifikat  
Normatives et certifications  
Normativas y certificados

## • ENVIRONMENTAL IMPACT - IMPATTO AMBIENTALE - UMWELTBELASTUNG - IMPACT DUR L'ENVIRONNEMENT - IMPACTO AMBIENTAL

MATERIAL Materiale	WEIGHT (Kg) Peso (Kg)	% TOTAL ITEM % totale articolo	MATERIAL RECYCLABILITY Riciclabilità' del materiale	% RECYCLED AT ORIGIN % riciclato all'origine	% RECYCLABLE END OF PRODUCT LIFE % riciclabile fine vita prodotto
Steel Acciaio	8,8	18,2	YES	33,2	100
Extruded aluminium Alluminio estruso	11,2	23,1	YES	0	100
Zamak Zama	0,3	0,6	YES	50	100
Technopolymer Tecnopolimero	0,04	0,1	YES	0	100
Polyethylene Polietilene	2,8	5,8	YES	0	100
Polyurethane foam Poliuretano espanso	21,5	44,3	NO	0	0
Teak Teak	2,27	4,7	YES	0	100
Fabric Tessuto	1,58	3,2	NO	0	0
<b>TOTAL TOTALE</b>	<b>48,5 Kg</b>	<b>--</b>	<b>--</b>	<b>6,3 %</b>	<b>52,4 %</b>

EN: Percentages referred to AS0022  
IT: Percentuali riferite a AS0022

## • COMPANY CERTIFICATIONS - CERTIFICAZIONI AZIENDALI - UNTERNEHMENSZERTIFIZIERUNGEN - CERTIFICATIONS D'ENTREPRISE - CERTIFICACIONES DE LA EMPRESA

**ISO 14001**  
Environmental management system  
Sistema di gestione ambientale



**ISO 9001**  
Quality management system  
Sistema di gestione della qualità

